







Assembly code	Assembly description	Assembly image
ASM3402A/0.D06	Cooking chamber	
ASM3408A/0.D04	External cover	
ASM3420B/0.D01	Door	
ASM8225A/0.D00	Electrical system	

ASM3402A/0.D06 - Cooking chamber - FRONT



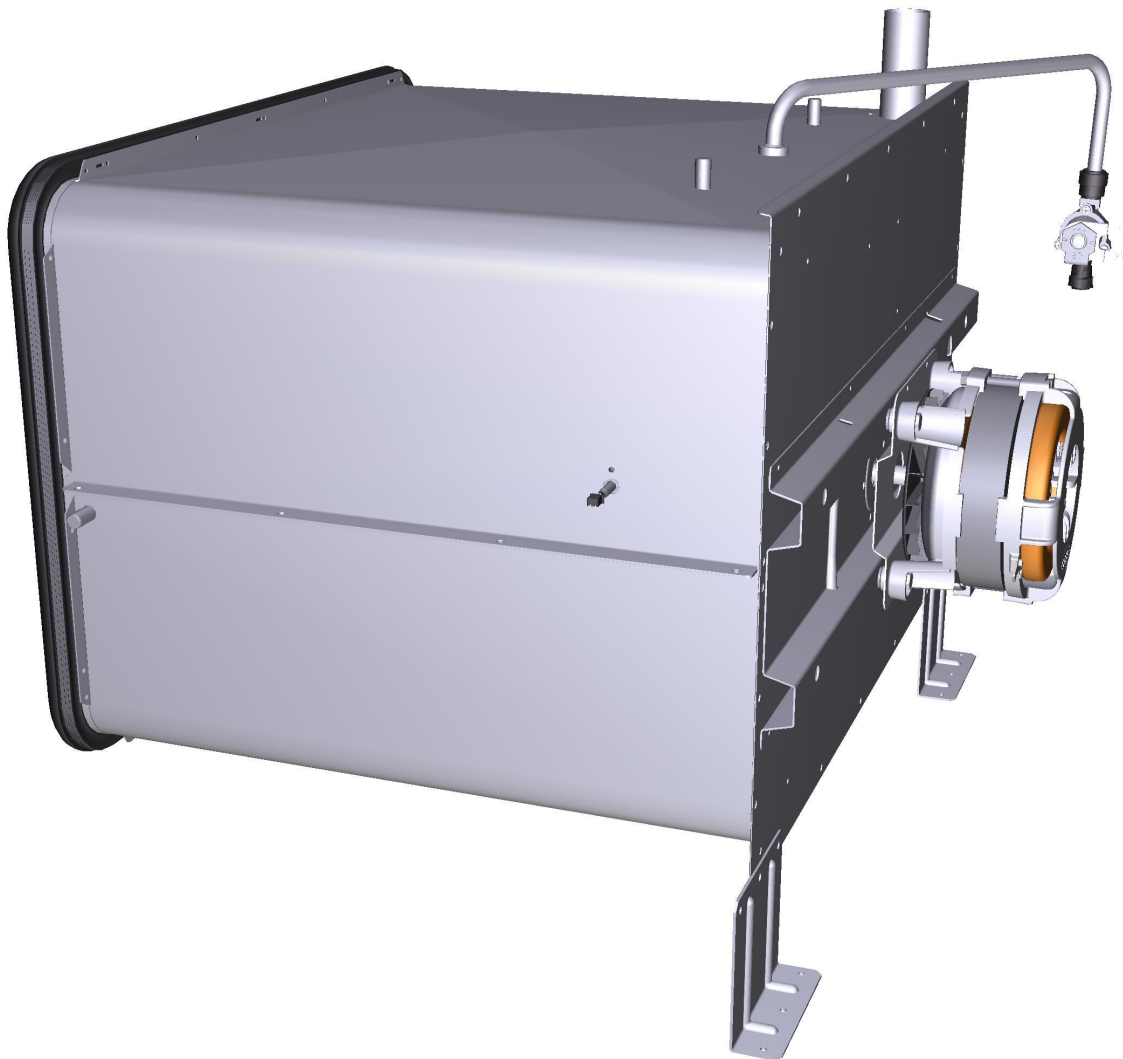



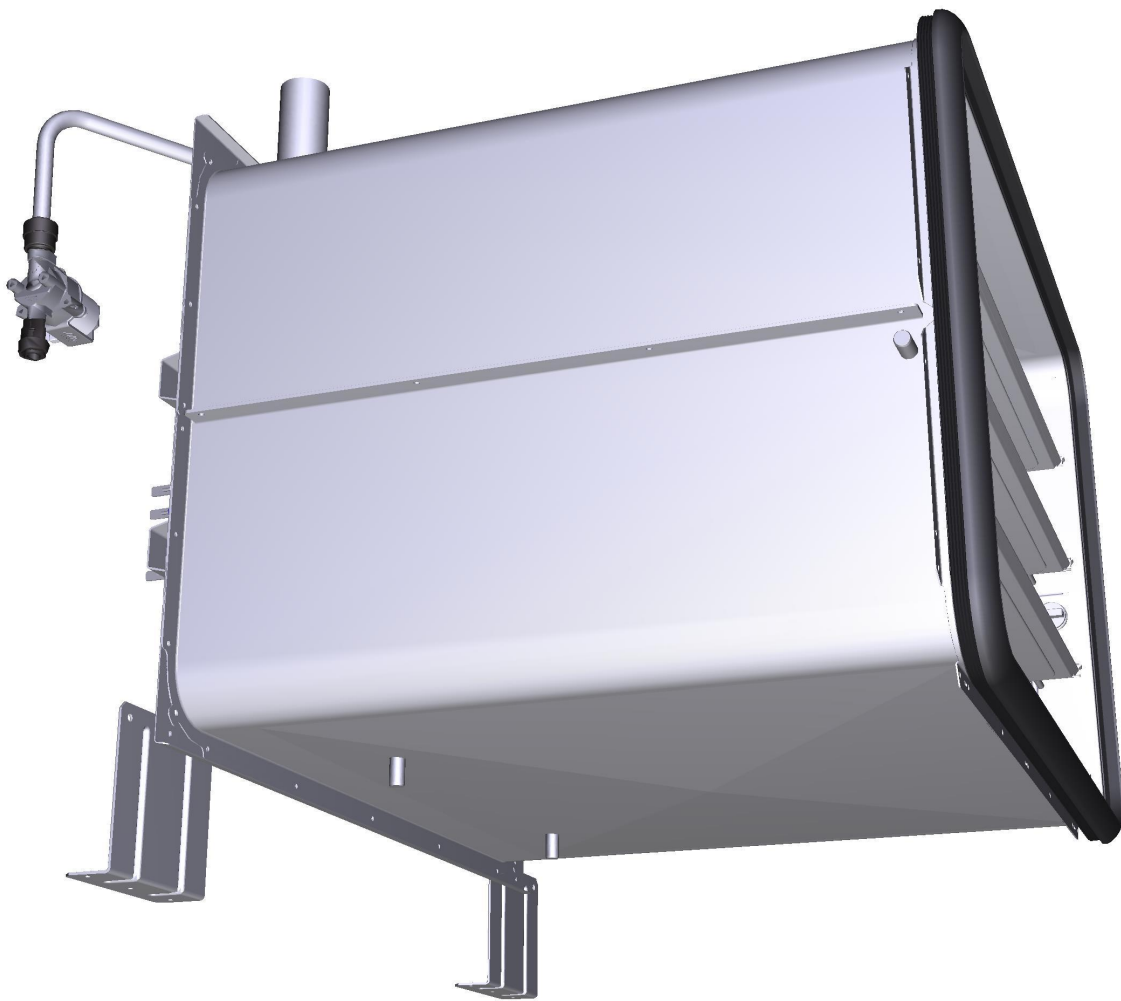



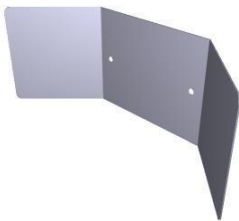

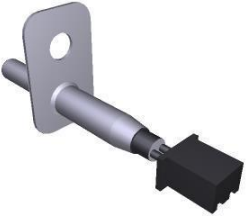
ASM3402A/0.D06 - Cooking chamber - REAR

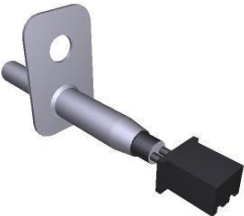





COMPONENT			SPARE PART																						
Code	Description	Image	Code	Description	Kit components																				
0C1544A	SHOP.PRO 04HS CHAMBER BACK WALL CORNER		0C1544A0	SHOP.PRO 04HS CHAMBER BACK WALL CORNER																					
0C1759A	0C1759A0		0C1759A0	0C1759A0																					
0G1652B	ARIANNA SP FAN GUARD		K0G1652B	ARIANNA BLSP FAN GUARD + HUMID. PIPE KIT	<table border="1"> <thead> <tr> <th>Code</th> <th>Description</th> <th>Qty</th> <th>UOM</th> </tr> </thead> <tbody> <tr> <td>0G1652B0</td> <td>ARIANNA SP FAN GUARD</td> <td>1.000</td> <td>PC</td> </tr> <tr> <td>TB1578B0</td> <td>ARIANNA SP INTERNAL HUMIDITY PIP</td> <td>1.000</td> <td>PC</td> </tr> <tr> <td>VI1220A1</td> <td>4,2x12 TCB SELF-TAPPIN G SCREW</td> <td>2.000</td> <td>PC</td> </tr> </tbody> </table>	Code	Description	Qty	UOM	0G1652B0	ARIANNA SP FAN GUARD	1.000	PC	TB1578B0	ARIANNA SP INTERNAL HUMIDITY PIP	1.000	PC	VI1220A1	4,2x12 TCB SELF-TAPPIN G SCREW	2.000	PC				
Code	Description	Qty	UOM																						
0G1652B0	ARIANNA SP FAN GUARD	1.000	PC																						
TB1578B0	ARIANNA SP INTERNAL HUMIDITY PIP	1.000	PC																						
VI1220A1	4,2x12 TCB SELF-TAPPIN G SCREW	2.000	PC																						
0H7875A	SHOP.PRO MUFFLE SUPPORT BRACKET		0H7875A1	SHOP.PRO MUFFLE SUPPORT BRACKET																					
TR1105A	L1000 PT100 TEMPERATURE PROBE		KTR1105A	PT100 L1000 TEMPERATURE PROBE KIT	<table border="1"> <thead> <tr> <th>Code</th> <th>Description</th> <th>Qty</th> <th>UOM</th> </tr> </thead> <tbody> <tr> <td>0H4302A0</td> <td>PROBES SILICON HOLDER</td> <td>1.000</td> <td>PC</td> </tr> <tr> <td>GN1120A1</td> <td>NTC TEMPERATUR E PROBE SEAL</td> <td>1.000</td> <td>PC</td> </tr> <tr> <td>GN1285A0</td> <td>NTC TEMPERATUR E PROBE SEALING</td> <td>1.000</td> <td>PC</td> </tr> <tr> <td>SL1045A0</td> <td>S57 BLACK SILICONE - 80ml CARTRIDGE</td> <td>1.000</td> <td>PC</td> </tr> </tbody> </table>	Code	Description	Qty	UOM	0H4302A0	PROBES SILICON HOLDER	1.000	PC	GN1120A1	NTC TEMPERATUR E PROBE SEAL	1.000	PC	GN1285A0	NTC TEMPERATUR E PROBE SEALING	1.000	PC	SL1045A0	S57 BLACK SILICONE - 80ml CARTRIDGE	1.000	PC
Code	Description	Qty	UOM																						
0H4302A0	PROBES SILICON HOLDER	1.000	PC																						
GN1120A1	NTC TEMPERATUR E PROBE SEAL	1.000	PC																						
GN1285A0	NTC TEMPERATUR E PROBE SEALING	1.000	PC																						
SL1045A0	S57 BLACK SILICONE - 80ml CARTRIDGE	1.000	PC																						



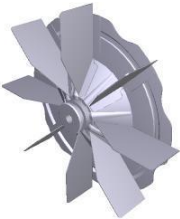

COMPONENT			SPARE PART																										
Code	Description	Image	Code	Description	Kit components																								
TR1105A	L1000 PT100 TEMPERATURE PROBE		KTR1105A	PT100 L1000 TEMPERATURE PROBE KIT	<table border="1"> <thead> <tr> <th>Code</th> <th>Description</th> <th>Qty</th> <th>UOM</th> </tr> </thead> <tbody> <tr> <td>TR1105A4</td> <td>L1000 PT100 TEMPERATUR E PROBE</td> <td>1.000</td> <td>PC</td> </tr> <tr> <td>VI1220A1</td> <td>4,2x12 TCB SELF-TAPPIN G SCREW</td> <td>2.000</td> <td>PC</td> </tr> <tr> <td>VM1464A1</td> <td>CT BT TEMPERATUR E PROBE COVER</td> <td>1.000</td> <td>PC</td> </tr> <tr> <td>VM1465A1</td> <td>CT BT TEMPERATUR E PROBE COVER</td> <td>1.000</td> <td>PC</td> </tr> <tr> <td>VM2052A0</td> <td>LM CORE PROBE COVE</td> <td>1.000</td> <td>PC</td> </tr> </tbody> </table>	Code	Description	Qty	UOM	TR1105A4	L1000 PT100 TEMPERATUR E PROBE	1.000	PC	VI1220A1	4,2x12 TCB SELF-TAPPIN G SCREW	2.000	PC	VM1464A1	CT BT TEMPERATUR E PROBE COVER	1.000	PC	VM1465A1	CT BT TEMPERATUR E PROBE COVER	1.000	PC	VM2052A0	LM CORE PROBE COVE	1.000	PC
Code	Description	Qty	UOM																										
TR1105A4	L1000 PT100 TEMPERATUR E PROBE	1.000	PC																										
VI1220A1	4,2x12 TCB SELF-TAPPIN G SCREW	2.000	PC																										
VM1464A1	CT BT TEMPERATUR E PROBE COVER	1.000	PC																										
VM1465A1	CT BT TEMPERATUR E PROBE COVER	1.000	PC																										
VM2052A0	LM CORE PROBE COVE	1.000	PC																										
EL1251A	1-WAY WATER SOLENOID VALVE		KEL1251A	JG D8-D10 1 WAY SOLENOID VALVE KI	<table border="1"> <thead> <tr> <th>Code</th> <th>Description</th> <th>Qty</th> <th>UOM</th> </tr> </thead> <tbody> <tr> <td>EL1251A0</td> <td>1-WAY WATER SOLENOID VALVE</td> <td>1.000</td> <td>PC</td> </tr> </tbody> </table>	Code	Description	Qty	UOM	EL1251A0	1-WAY WATER SOLENOID VALVE	1.000	PC																
Code	Description	Qty	UOM																										
EL1251A0	1-WAY WATER SOLENOID VALVE	1.000	PC																										
0H3020A	MOTOR SHAFT SEALING DISC		0H3020A1	MOTOR SHAFT SEALING DISC																									
0H7170A	MM MOTOR GLASS WOOL PLATE		0H7170A0	MM MOTOR GLASS WOOL PLATE																									

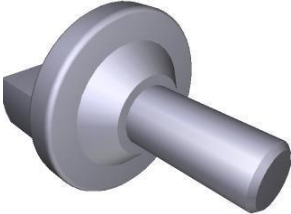
COMPONENT			SPARE PART																																		
Code	Description	Image	Code	Description	Kit components																																
GN1547A	SHAFT GASKET D11.8		KGN1547A	D11.6 MOTOR SHAFT GASKET 3PCS KIT	<table border="1"> <thead> <tr> <th>Code</th> <th>Description</th> <th>Qty</th> <th>UOM</th> </tr> </thead> <tbody> <tr> <td>GN1547A1</td> <td>SHAFT GASKET D11.8</td> <td>3.000</td> <td>PC</td> </tr> </tbody> </table>	Code	Description	Qty	UOM	GN1547A1	SHAFT GASKET D11.8	3.000	PC																								
Code	Description	Qty	UOM																																		
GN1547A1	SHAFT GASKET D11.8	3.000	PC																																		
MT1012A	330W 230V MOTOR		KVN1130A	LUX ≤08.2017/L.MISS/S.5/ 5E MOTOR KIT	<table border="1"> <thead> <tr> <th>Code</th> <th>Description</th> <th>Qty</th> <th>UOM</th> </tr> </thead> <tbody> <tr> <td>0H8118A0</td> <td>XEVL MOTOR SHAFT DISC</td> <td>1.000</td> <td>PC</td> </tr> <tr> <td>GN1140A3</td> <td>MOLDED MOTOR HOLDER GASKET</td> <td>1.000</td> <td>PC</td> </tr> <tr> <td>VI1034A0</td> <td>STAINLESS STEEL WASHER 8.4x16x1</td> <td>1.000</td> <td>PC</td> </tr> <tr> <td>VI1256A0</td> <td>M8 DIN 980M ST. STEEL SELF LOCKING NUT</td> <td>1.000</td> <td>PC</td> </tr> <tr> <td>VM2196A0</td> <td>MOTOR NUT FASTENING BUSHING</td> <td>1.000</td> <td>PC</td> </tr> <tr> <td>VN1130A1</td> <td>330W 230V 50/60HZ MOTO</td> <td>1.000</td> <td>PC</td> </tr> </tbody> </table>	Code	Description	Qty	UOM	0H8118A0	XEVL MOTOR SHAFT DISC	1.000	PC	GN1140A3	MOLDED MOTOR HOLDER GASKET	1.000	PC	VI1034A0	STAINLESS STEEL WASHER 8.4x16x1	1.000	PC	VI1256A0	M8 DIN 980M ST. STEEL SELF LOCKING NUT	1.000	PC	VM2196A0	MOTOR NUT FASTENING BUSHING	1.000	PC	VN1130A1	330W 230V 50/60HZ MOTO	1.000	PC				
Code	Description	Qty	UOM																																		
0H8118A0	XEVL MOTOR SHAFT DISC	1.000	PC																																		
GN1140A3	MOLDED MOTOR HOLDER GASKET	1.000	PC																																		
VI1034A0	STAINLESS STEEL WASHER 8.4x16x1	1.000	PC																																		
VI1256A0	M8 DIN 980M ST. STEEL SELF LOCKING NUT	1.000	PC																																		
VM2196A0	MOTOR NUT FASTENING BUSHING	1.000	PC																																		
VN1130A1	330W 230V 50/60HZ MOTO	1.000	PC																																		
			KMT1012A	LUX >08.2017 / MIND.MAPS 330W MOTOR KIT	<table border="1"> <thead> <tr> <th>Code</th> <th>Description</th> <th>Qty</th> <th>UOM</th> </tr> </thead> <tbody> <tr> <td>0H2842A0</td> <td>MT1012 CENTERING JI</td> <td>1.000</td> <td>PC</td> </tr> <tr> <td>0H8118A0</td> <td>XEVL MOTOR SHAFT DISC</td> <td>1.000</td> <td>PC</td> </tr> <tr> <td>GN1140A3</td> <td>MOLDED MOTOR HOLDER GASKET</td> <td>1.000</td> <td>PC</td> </tr> <tr> <td>MT1012A0</td> <td>330W 230V MOTOR</td> <td>1.000</td> <td>PC</td> </tr> <tr> <td>VI1077A1</td> <td>SCREW M6x12 TE INOX</td> <td>1.000</td> <td>PC</td> </tr> <tr> <td>VI1521A0</td> <td>STAINLESS STEEL WASHER D=6 6592</td> <td>1.000</td> <td>PC</td> </tr> <tr> <td>VI1966A1</td> <td>M4x14 FLATHEAD SCREW</td> <td>1.000</td> <td>PC</td> </tr> </tbody> </table>	Code	Description	Qty	UOM	0H2842A0	MT1012 CENTERING JI	1.000	PC	0H8118A0	XEVL MOTOR SHAFT DISC	1.000	PC	GN1140A3	MOLDED MOTOR HOLDER GASKET	1.000	PC	MT1012A0	330W 230V MOTOR	1.000	PC	VI1077A1	SCREW M6x12 TE INOX	1.000	PC	VI1521A0	STAINLESS STEEL WASHER D=6 6592	1.000	PC	VI1966A1	M4x14 FLATHEAD SCREW	1.000	PC
Code	Description	Qty	UOM																																		
0H2842A0	MT1012 CENTERING JI	1.000	PC																																		
0H8118A0	XEVL MOTOR SHAFT DISC	1.000	PC																																		
GN1140A3	MOLDED MOTOR HOLDER GASKET	1.000	PC																																		
MT1012A0	330W 230V MOTOR	1.000	PC																																		
VI1077A1	SCREW M6x12 TE INOX	1.000	PC																																		
VI1521A0	STAINLESS STEEL WASHER D=6 6592	1.000	PC																																		
VI1966A1	M4x14 FLATHEAD SCREW	1.000	PC																																		

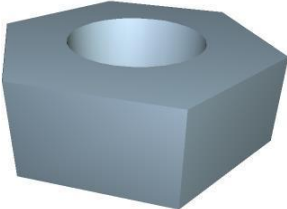

COMPONENT			SPARE PART																										
Code	Description	Image	Code	Description	Kit components																								
VN1172A	M8 NUT 8 BLADES H40 D195 FAN		KVN1172A	D195 H40 M8 NUT 8 BLADES FAN KIT	<table border="1"> <thead> <tr> <th>Code</th> <th>Description</th> <th>Qty</th> <th>UOM</th> </tr> </thead> <tbody> <tr> <td>VI1077A1</td> <td>SCREW M6x12 TE INOX</td> <td>1.000</td> <td>PC</td> </tr> <tr> <td>VI1521A0</td> <td>STAINLESS STEEL WASHER D=6 6592</td> <td>1.000</td> <td>PC</td> </tr> <tr> <td>VN1172A0</td> <td>M8 NUT 8 BLADES H40 D195 FAN</td> <td>1.000</td> <td>PC</td> </tr> </tbody> </table>	Code	Description	Qty	UOM	VI1077A1	SCREW M6x12 TE INOX	1.000	PC	VI1521A0	STAINLESS STEEL WASHER D=6 6592	1.000	PC	VN1172A0	M8 NUT 8 BLADES H40 D195 FAN	1.000	PC								
Code	Description	Qty	UOM																										
VI1077A1	SCREW M6x12 TE INOX	1.000	PC																										
VI1521A0	STAINLESS STEEL WASHER D=6 6592	1.000	PC																										
VN1172A0	M8 NUT 8 BLADES H40 D195 FAN	1.000	PC																										
RS1283B	3200W 230V+260W 135V 4TURNS H60 ELEMENT		KRS1283B	4TURN HEAT ELEM 3000W 230V+260W 135V KIT	<table border="1"> <thead> <tr> <th>Code</th> <th>Description</th> <th>Qty</th> <th>UOM</th> </tr> </thead> <tbody> <tr> <td>GN1327A0</td> <td>HEATING ELEMENT GASKET</td> <td>1.000</td> <td>PC</td> </tr> <tr> <td>RS1283B0</td> <td>3200W 230V+260W 135V 4TURNS H60 ELEMENT</td> <td>1.000</td> <td>PC</td> </tr> <tr> <td>SL1045A0</td> <td>S57 BLACK SILICONE - 80ml CARTRIDGE</td> <td>1.000</td> <td>PC</td> </tr> <tr> <td>VI1220A1</td> <td>4,2x12 TCB SELF-TAPPIN G SCREW</td> <td>2.000</td> <td>PC</td> </tr> <tr> <td>VM1794A0</td> <td>250x4.8 PA66 BLACK CLAMP</td> <td>2.000</td> <td>PC</td> </tr> </tbody> </table>	Code	Description	Qty	UOM	GN1327A0	HEATING ELEMENT GASKET	1.000	PC	RS1283B0	3200W 230V+260W 135V 4TURNS H60 ELEMENT	1.000	PC	SL1045A0	S57 BLACK SILICONE - 80ml CARTRIDGE	1.000	PC	VI1220A1	4,2x12 TCB SELF-TAPPIN G SCREW	2.000	PC	VM1794A0	250x4.8 PA66 BLACK CLAMP	2.000	PC
Code	Description	Qty	UOM																										
GN1327A0	HEATING ELEMENT GASKET	1.000	PC																										
RS1283B0	3200W 230V+260W 135V 4TURNS H60 ELEMENT	1.000	PC																										
SL1045A0	S57 BLACK SILICONE - 80ml CARTRIDGE	1.000	PC																										
VI1220A1	4,2x12 TCB SELF-TAPPIN G SCREW	2.000	PC																										
VM1794A0	250x4.8 PA66 BLACK CLAMP	2.000	PC																										
GRL1010A	Arianna LineMiss RIGHT/LEFT LATERAL GRID		KGRL1010A	R/L CHROM. PLATED LATERAL SUPP KIT	<table border="1"> <thead> <tr> <th>Code</th> <th>Description</th> <th>Qty</th> <th>UOM</th> </tr> </thead> <tbody> <tr> <td>GRL1010A2</td> <td>Arianna LineMiss RIGHT/LEFT LATERAL GRID</td> <td>2.000</td> <td>PC</td> </tr> </tbody> </table>	Code	Description	Qty	UOM	GRL1010A2	Arianna LineMiss RIGHT/LEFT LATERAL GRID	2.000	PC																
Code	Description	Qty	UOM																										
GRL1010A2	Arianna LineMiss RIGHT/LEFT LATERAL GRID	2.000	PC																										
VM1815A	LATERAL SUPPORTS FIXING BOLT		KVM1815A	MISS/MICRO/S4/S3 THUMB SCREW 10 PCS KIT	<table border="1"> <thead> <tr> <th>Code</th> <th>Description</th> <th>Qty</th> <th>UOM</th> </tr> </thead> <tbody> <tr> <td>VM1815A0</td> <td>LATERAL SUPPORTS FIXING BOLT</td> <td>10.000</td> <td>PC</td> </tr> </tbody> </table>	Code	Description	Qty	UOM	VM1815A0	LATERAL SUPPORTS FIXING BOLT	10.000	PC																
Code	Description	Qty	UOM																										
VM1815A0	LATERAL SUPPORTS FIXING BOLT	10.000	PC																										



COMPONENT			SPARE PART														
Code	Description	Image	Code	Description	Kit components												
GN1352A	GN1352A3		KGN1352A	LM ARIANNA/BT CABINET DOOR GASKET KIT	<table border="1"> <thead> <tr> <th>Code</th> <th>Description</th> <th>Qty</th> <th>UOM</th> </tr> </thead> <tbody> <tr> <td>GN1352A3</td> <td>GN1352A3</td> <td>1.000</td> <td>PC</td> </tr> <tr> <td>VM2277A0</td> <td>DOOR SEAL KIT INTERNAL CONNECTION</td> <td>1.000</td> <td>PC</td> </tr> </tbody> </table>	Code	Description	Qty	UOM	GN1352A3	GN1352A3	1.000	PC	VM2277A0	DOOR SEAL KIT INTERNAL CONNECTION	1.000	PC
Code	Description	Qty	UOM														
GN1352A3	GN1352A3	1.000	PC														
VM2277A0	DOOR SEAL KIT INTERNAL CONNECTION	1.000	PC														
RC1170A	M14 H=7 CH=22 STAINLESS STEEL NUT		KRC1170A	M14 H8 CH22 NUT - 10 PCS. KIT	<table border="1"> <thead> <tr> <th>Code</th> <th>Description</th> <th>Qty</th> <th>UOM</th> </tr> </thead> <tbody> <tr> <td>RC1170A1</td> <td>M14 H=7 CH=22 STAINLESS STEEL NUT</td> <td>10.000</td> <td>PC</td> </tr> </tbody> </table>	Code	Description	Qty	UOM	RC1170A1	M14 H=7 CH=22 STAINLESS STEEL NUT	10.000	PC				
Code	Description	Qty	UOM														
RC1170A1	M14 H=7 CH=22 STAINLESS STEEL NUT	10.000	PC														
TB1568A	ARI-STE-ROS SP WELDED EXT HUMIDITY PIPE		TB1568A0	ARI-STE-ROS SP WELDED EXT HUMIDITY PIPE													
TB1574A	FUME CHIMNEY D30 SHOP PRO		TB1574A0	FUME CHIMNEY D30 SHOP PRO													
TB1578B	ARIANNA SP INTERNAL HUMIDITY PIPE		TB1578B0	ARIANNA SP INTERNAL HUMIDITY PIPE													



ASM3408A/0.D04 - External cover - FRONT











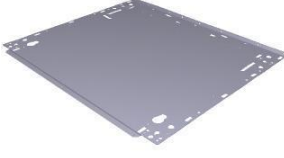

ASM3408A/0.D04 - External cover - REAR



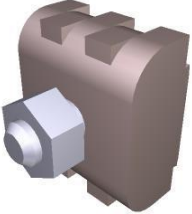

COMPONENT			SPARE PART														
Code	Description	Image	Code	Description	Kit components												
0D2402B	SP DROP-DOWN ARIANNA OVEN EXT CASING		0D2402B2	SP DROP-DOWN ARIANNA OVEN EXT CASING													
0D2409A	SP600 INF FRONT PROFILE DROP DOWN DOOR		0D2409A1	SP600 INF FRONT PROFILE DROP DOWN DOOR													
0E1381A	SP600 EXTERNAL BOTTOM PANEL		0E1381A1	SP600 EXTERNAL BOTTOM PANEL													
0F1542B	ARIANNA SP BACK PANEL		0F1542B0	ARIANNA SP BACK PANEL													
CR1000A	HINGE LATCH L.M.		KCR1000A	LM HINGES LATCH KIT	<table border="1"> <thead> <tr> <th>Code</th> <th>Description</th> <th>Qty</th> <th>UOM</th> </tr> </thead> <tbody> <tr> <td>CR1000A0</td> <td>HINGE LATCH L.M.</td> <td>1.000</td> <td>PC</td> </tr> <tr> <td>VI1280A3</td> <td>M5x10 TC1/2T SCREW</td> <td>2.000</td> <td>PC</td> </tr> </tbody> </table>	Code	Description	Qty	UOM	CR1000A0	HINGE LATCH L.M.	1.000	PC	VI1280A3	M5x10 TC1/2T SCREW	2.000	PC
Code	Description	Qty	UOM														
CR1000A0	HINGE LATCH L.M.	1.000	PC														
VI1280A3	M5x10 TC1/2T SCREW	2.000	PC														



COMPONENT			SPARE PART														
Code	Description	Image	Code	Description	Kit components												
VM1750A	BRASS COMB CLAM		KVM1750A	COMB TERMINAL BLOCK KIT	<table border="1"> <thead> <tr> <th>Code</th> <th>Description</th> <th>Qty</th> <th>UOM</th> </tr> </thead> <tbody> <tr> <td>V11040A0</td> <td>INDENTED INTERNAL WASHER D=6 ZN</td> <td>2.000</td> <td>PC</td> </tr> <tr> <td>VM1750A0</td> <td>BRASS COMB CLAMP</td> <td>1.000</td> <td>PC</td> </tr> </tbody> </table>	Code	Description	Qty	UOM	V11040A0	INDENTED INTERNAL WASHER D=6 ZN	2.000	PC	VM1750A0	BRASS COMB CLAMP	1.000	PC
Code	Description	Qty	UOM														
V11040A0	INDENTED INTERNAL WASHER D=6 ZN	2.000	PC														
VM1750A0	BRASS COMB CLAMP	1.000	PC														
VM2502A	BAKERLUX SHOP.PRO CHIMNEY RING		KVM2502A	BAKERLUX SHOP.PRO CHIMNEY RING KIT	<table border="1"> <thead> <tr> <th>Code</th> <th>Description</th> <th>Qty</th> <th>UOM</th> </tr> </thead> <tbody> <tr> <td>VM2502A0</td> <td>BAKERLUX SHOP.PRO CHIMNEY RIN</td> <td>1.000</td> <td>PC</td> </tr> </tbody> </table>	Code	Description	Qty	UOM	VM2502A0	BAKERLUX SHOP.PRO CHIMNEY RIN	1.000	PC				
Code	Description	Qty	UOM														
VM2502A0	BAKERLUX SHOP.PRO CHIMNEY RIN	1.000	PC														
VM2495A	SP COOLING FAN SUPPORT		KVM2495A	COOLING FAN SUPPORT KIT	<table border="1"> <thead> <tr> <th>Code</th> <th>Description</th> <th>Qty</th> <th>UOM</th> </tr> </thead> <tbody> <tr> <td>V11220A1</td> <td>4,2x12 TCB SELF-TAPPING SCREW</td> <td>2.000</td> <td>PC</td> </tr> <tr> <td>VM2495A0</td> <td>SP COOLING FAN SUPPORT</td> <td>1.000</td> <td>PC</td> </tr> </tbody> </table>	Code	Description	Qty	UOM	V11220A1	4,2x12 TCB SELF-TAPPING SCREW	2.000	PC	VM2495A0	SP COOLING FAN SUPPORT	1.000	PC
Code	Description	Qty	UOM														
V11220A1	4,2x12 TCB SELF-TAPPING SCREW	2.000	PC														
VM2495A0	SP COOLING FAN SUPPORT	1.000	PC														
VN1175A	230V 50/60Hz 120x120 COOLING DOWN FAN		KVN1175A	120x120 230V 50/60Hz COOLING FAN KIT	<table border="1"> <thead> <tr> <th>Code</th> <th>Description</th> <th>Qty</th> <th>UOM</th> </tr> </thead> <tbody> <tr> <td>VN1175A0</td> <td>230V 50/60Hz 120x120 COOLING DOWN FAN</td> <td>1.000</td> <td>PC</td> </tr> </tbody> </table>	Code	Description	Qty	UOM	VN1175A0	230V 50/60Hz 120x120 COOLING DOWN FAN	1.000	PC				
Code	Description	Qty	UOM														
VN1175A0	230V 50/60Hz 120x120 COOLING DOWN FAN	1.000	PC														
VE1295A	MK 16A 230V DOOR MICROSWITCH		KVE1295A	16A 230V DOOR MICROSWITCH KIT	<table border="1"> <thead> <tr> <th>Code</th> <th>Description</th> <th>Qty</th> <th>UOM</th> </tr> </thead> <tbody> <tr> <td>VE1295A0</td> <td>MK 16A 230V DOOR MICROSWITC</td> <td>1.000</td> <td>PC</td> </tr> </tbody> </table>	Code	Description	Qty	UOM	VE1295A0	MK 16A 230V DOOR MICROSWITC	1.000	PC				
Code	Description	Qty	UOM														
VE1295A0	MK 16A 230V DOOR MICROSWITC	1.000	PC														



COMPONENT			SPARE PART										
Code	Description	Image	Code	Description	Kit components								
VM2508A	BAKERLUX SHOP.PRO DOOR SWITCH COVER		KVM2508A	BAKERLUX SHOP.PRO MICROSWITCH COVER KIT	<table border="1"> <thead> <tr> <th>Code</th> <th>Description</th> <th>Qty</th> <th>UOM</th> </tr> </thead> <tbody> <tr> <td>VM2508A0</td> <td>BAKERLUX SHOP.PRO DOOR SWITCH COVE</td> <td>1.000</td> <td>PC</td> </tr> </tbody> </table>	Code	Description	Qty	UOM	VM2508A0	BAKERLUX SHOP.PRO DOOR SWITCH COVE	1.000	PC
Code	Description	Qty	UOM										
VM2508A0	BAKERLUX SHOP.PRO DOOR SWITCH COVE	1.000	PC										
VM2481A	FRONT EXTERNAL COVER LEFT CAP S		KVM2481A	BL SP LEFT EXT COVER FRONT PANEL CAP KIT	<table border="1"> <thead> <tr> <th>Code</th> <th>Description</th> <th>Qty</th> <th>UOM</th> </tr> </thead> <tbody> <tr> <td>VM2481A0</td> <td>FRONT EXTERNAL COVER LEFT CAP SP</td> <td>1.000</td> <td>PC</td> </tr> </tbody> </table>	Code	Description	Qty	UOM	VM2481A0	FRONT EXTERNAL COVER LEFT CAP SP	1.000	PC
Code	Description	Qty	UOM										
VM2481A0	FRONT EXTERNAL COVER LEFT CAP SP	1.000	PC										
VM2480A	FRONT EXTERNAL COVER RIGHT CAP SP		KVM2480A	BL SP RIGHT EXT COVER FRONT PANEL CAP	<table border="1"> <thead> <tr> <th>Code</th> <th>Description</th> <th>Qty</th> <th>UOM</th> </tr> </thead> <tbody> <tr> <td>VM2480A0</td> <td>FRONT EXTERNAL COVER RIGHT CAP SP</td> <td>1.000</td> <td>PC</td> </tr> </tbody> </table>	Code	Description	Qty	UOM	VM2480A0	FRONT EXTERNAL COVER RIGHT CAP SP	1.000	PC
Code	Description	Qty	UOM										
VM2480A0	FRONT EXTERNAL COVER RIGHT CAP SP	1.000	PC										
VM1631A	PLUS INNER GLASS PUSHING CAP		KVM1631A	CAP FOR INTERNAL GLASS 10 PCS KIT	<table border="1"> <thead> <tr> <th>Code</th> <th>Description</th> <th>Qty</th> <th>UOM</th> </tr> </thead> <tbody> <tr> <td>VM1631A0</td> <td>PLUS INNER GLASS PUSHING CAP</td> <td>10.000</td> <td>PC</td> </tr> </tbody> </table>	Code	Description	Qty	UOM	VM1631A0	PLUS INNER GLASS PUSHING CAP	10.000	PC
Code	Description	Qty	UOM										
VM1631A0	PLUS INNER GLASS PUSHING CAP	10.000	PC										
VM2490A	460X330 SP EXT FRONT BOTTOM GASKET		KVM2490A	SP 460X330 EXT BOTTOM PANEL GASKET KIT	<table border="1"> <thead> <tr> <th>Code</th> <th>Description</th> <th>Qty</th> <th>UOM</th> </tr> </thead> <tbody> <tr> <td>VM2490A0</td> <td>460X330 SP EXT FRONT BOTTOM GASKET</td> <td>2.000</td> <td>PC</td> </tr> </tbody> </table>	Code	Description	Qty	UOM	VM2490A0	460X330 SP EXT FRONT BOTTOM GASKET	2.000	PC
Code	Description	Qty	UOM										
VM2490A0	460X330 SP EXT FRONT BOTTOM GASKET	2.000	PC										



COMPONENT			SPARE PART														
Code	Description	Image	Code	Description	Kit components												
VM2491A	460x330 BLSP LATERAL BOTTOM PANEL GASKET		KVM2491A	SP 460X330 LAT BOTT PANEL GASKET 2PC KIT	<table border="1"> <thead> <tr> <th>Code</th> <th>Description</th> <th>Qty</th> <th>UOM</th> </tr> </thead> <tbody> <tr> <td>VM1631A0</td> <td>PLUS INNER GLASS PUSHING CAP</td> <td>4.000</td> <td>PC</td> </tr> <tr> <td>VM2491A1</td> <td>460x330 BLSP LATERAL BOTTOM PANEL GASKE</td> <td>2.000</td> <td>PC</td> </tr> </tbody> </table>	Code	Description	Qty	UOM	VM1631A0	PLUS INNER GLASS PUSHING CAP	4.000	PC	VM2491A1	460x330 BLSP LATERAL BOTTOM PANEL GASKE	2.000	PC
Code	Description	Qty	UOM														
VM1631A0	PLUS INNER GLASS PUSHING CAP	4.000	PC														
VM2491A1	460x330 BLSP LATERAL BOTTOM PANEL GASKE	2.000	PC														
VM1222A	CABLE LOCKS SP ACCESSORIES EL CONNECTION		VM1222A0	CABLE LOCKS SP ACCESSORIES EL CONNECTION													
VM2249A	COOKING CHAMBER FRONT CORNER		KVM2249A	CHAMBER FRONT PROFILE CORNER KIT	<table border="1"> <thead> <tr> <th>Code</th> <th>Description</th> <th>Qty</th> <th>UOM</th> </tr> </thead> <tbody> <tr> <td>VM2249A0</td> <td>COOKING CHAMBER FRONT CORNER</td> <td>1.000</td> <td>PC</td> </tr> </tbody> </table>	Code	Description	Qty	UOM	VM2249A0	COOKING CHAMBER FRONT CORNER	1.000	PC				
Code	Description	Qty	UOM														
VM2249A0	COOKING CHAMBER FRONT CORNER	1.000	PC														
VM2455A	SP CONTROL BOARD CABLE PASS-THROUGH CLI		KVM2455A	BL SP CONTR BOARD CABLE PASS-THROUGH KIT	<table border="1"> <thead> <tr> <th>Code</th> <th>Description</th> <th>Qty</th> <th>UOM</th> </tr> </thead> <tbody> <tr> <td>VM2455A1</td> <td>SP CONTROL BOARD CABLE PASS-THROU GH CLIP</td> <td>1.000</td> <td>PC</td> </tr> </tbody> </table>	Code	Description	Qty	UOM	VM2455A1	SP CONTROL BOARD CABLE PASS-THROU GH CLIP	1.000	PC				
Code	Description	Qty	UOM														
VM2455A1	SP CONTROL BOARD CABLE PASS-THROU GH CLIP	1.000	PC														

ASM3420B/0.D01 - Door - FRONT

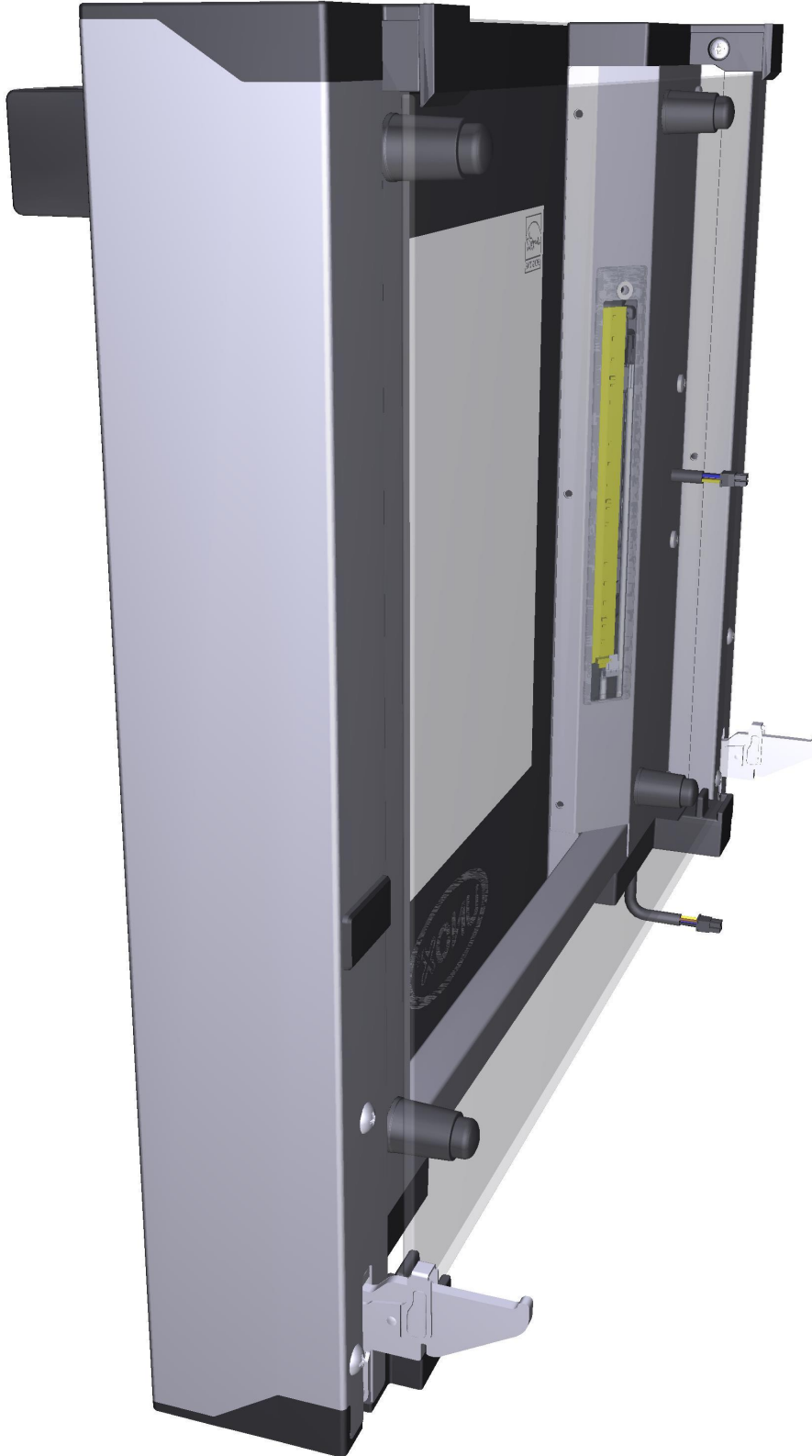





ASM3420B/0.D01 - Door - REAR



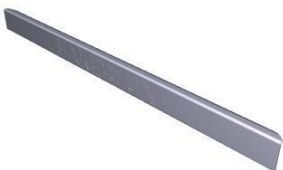

COMPONENT			SPARE PART																										
Code	Description	Image	Code	Description	Kit components																								
0B1290A	SP ARI-ROS DROPDOWN DOOR LEFT INT COLUMN		0B1290A0	SP ARI-ROS DROPDOWN DOOR LEFT INT COLUMN																									
0B1292A	SP ARI-ROS DROPDOWN DOOR RT INNER COLUMN		0B1292A0	SP ARI-ROS DROPDOWN DOOR RT INNER COLUMN																									
LP1050A	BL SHOP.PRO L180 COMPLETE LED BA		KLP1050A	L180 COMPLETE LED LIGHT BAR KIT	<table border="1"> <thead> <tr> <th>Code</th> <th>Description</th> <th>Qty</th> <th>UOM</th> </tr> </thead> <tbody> <tr> <td>LP1050A0</td> <td>BL SHOP.PRO L180 COMPLETE LED BAR</td> <td>1.000</td> <td>PC</td> </tr> <tr> <td>VI1014A0</td> <td>STAINLESS STEEL WASHER 4.5X9X0.8</td> <td>1.000</td> <td>PC</td> </tr> <tr> <td>VI1220A1</td> <td>4,2x12 TCB SELF-TAPPING SCREW</td> <td>1.000</td> <td>PC</td> </tr> </tbody> </table>	Code	Description	Qty	UOM	LP1050A0	BL SHOP.PRO L180 COMPLETE LED BAR	1.000	PC	VI1014A0	STAINLESS STEEL WASHER 4.5X9X0.8	1.000	PC	VI1220A1	4,2x12 TCB SELF-TAPPING SCREW	1.000	PC								
Code	Description	Qty	UOM																										
LP1050A0	BL SHOP.PRO L180 COMPLETE LED BAR	1.000	PC																										
VI1014A0	STAINLESS STEEL WASHER 4.5X9X0.8	1.000	PC																										
VI1220A1	4,2x12 TCB SELF-TAPPING SCREW	1.000	PC																										
TB3301A	TB3301A0		KTB3301A	BL SP 460X330 DROPDOWN HANDLE TUBE KIT	<table border="1"> <thead> <tr> <th>Code</th> <th>Description</th> <th>Qty</th> <th>UOM</th> </tr> </thead> <tbody> <tr> <td>TB3301A0</td> <td>TB3301A0</td> <td>1.000</td> <td>PC</td> </tr> <tr> <td>VI1147A0</td> <td>5X25 STAINLESS STEEL SCREW</td> <td>4.000</td> <td>PC</td> </tr> <tr> <td>VM2456A0</td> <td>BAKERLUX SHOP.PRO HANDLE END</td> <td>1.000</td> <td>PC</td> </tr> <tr> <td>VM2489A0</td> <td>SP HANDLE END KIT + STYLUS KIT</td> <td>1.000</td> <td>PC</td> </tr> <tr> <td>VM2527A1</td> <td>EVEREO-S.Pro DISPLAY STYLUS</td> <td>1.000</td> <td>PC</td> </tr> </tbody> </table>	Code	Description	Qty	UOM	TB3301A0	TB3301A0	1.000	PC	VI1147A0	5X25 STAINLESS STEEL SCREW	4.000	PC	VM2456A0	BAKERLUX SHOP.PRO HANDLE END	1.000	PC	VM2489A0	SP HANDLE END KIT + STYLUS KIT	1.000	PC	VM2527A1	EVEREO-S.Pro DISPLAY STYLUS	1.000	PC
Code	Description	Qty	UOM																										
TB3301A0	TB3301A0	1.000	PC																										
VI1147A0	5X25 STAINLESS STEEL SCREW	4.000	PC																										
VM2456A0	BAKERLUX SHOP.PRO HANDLE END	1.000	PC																										
VM2489A0	SP HANDLE END KIT + STYLUS KIT	1.000	PC																										
VM2527A1	EVEREO-S.Pro DISPLAY STYLUS	1.000	PC																										









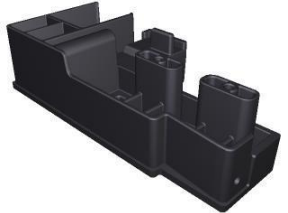

COMPONENT			SPARE PART																						
Code	Description	Image	Code	Description	Kit components																				
VM2456A	BAKERLUX SHOP.PRO HANDLE END		KVM2456A	2 PCS BAKERLUX SHOP.PRO HANDLE END KIT	<table border="1"> <thead> <tr> <th>Code</th> <th>Description</th> <th>Qty</th> <th>UOM</th> </tr> </thead> <tbody> <tr> <td>VI1147A0</td> <td>5X25 STAINLESS STEEL SCREW</td> <td>4.000</td> <td>PC</td> </tr> <tr> <td>VM2456A0</td> <td>BAKERLUX SHOP.PRO HANDLE END</td> <td>1.000</td> <td>PC</td> </tr> <tr> <td>VM2489A0</td> <td>SP HANDLE END KIT + STYLUS KIT</td> <td>1.000</td> <td>PC</td> </tr> <tr> <td>VM2527A1</td> <td>EVEREO-S.Pro DISPLAY STYLUS</td> <td>1.000</td> <td>PC</td> </tr> </tbody> </table>	Code	Description	Qty	UOM	VI1147A0	5X25 STAINLESS STEEL SCREW	4.000	PC	VM2456A0	BAKERLUX SHOP.PRO HANDLE END	1.000	PC	VM2489A0	SP HANDLE END KIT + STYLUS KIT	1.000	PC	VM2527A1	EVEREO-S.Pro DISPLAY STYLUS	1.000	PC
					Code	Description	Qty	UOM																	
					VI1147A0	5X25 STAINLESS STEEL SCREW	4.000	PC																	
					VM2456A0	BAKERLUX SHOP.PRO HANDLE END	1.000	PC																	
VM2489A0	SP HANDLE END KIT + STYLUS KIT	1.000	PC																						
VM2527A1	EVEREO-S.Pro DISPLAY STYLUS	1.000	PC																						
VM2471A	BL SP LOWER CLAMP INT LOCK GLASS SLIDER		KVM2471A	BL SP INTERNAL GLASS LOCK HOLDER KIT	<table border="1"> <thead> <tr> <th>Code</th> <th>Description</th> <th>Qty</th> <th>UOM</th> </tr> </thead> <tbody> <tr> <td>VI1998A0</td> <td>ZINC PLATED SCREW 5X30 TCB</td> <td>2.000</td> <td>PC</td> </tr> <tr> <td>VM2471A0</td> <td>BL SP LOWER CLAMP INT LOCK GLASS SLIDER</td> <td>1.000</td> <td>PC</td> </tr> <tr> <td>VM2472A0</td> <td>BL SP UPPER CLAMP INT LOCK GLASS SLIDER</td> <td>1.000</td> <td>PC</td> </tr> </tbody> </table>	Code	Description	Qty	UOM	VI1998A0	ZINC PLATED SCREW 5X30 TCB	2.000	PC	VM2471A0	BL SP LOWER CLAMP INT LOCK GLASS SLIDER	1.000	PC	VM2472A0	BL SP UPPER CLAMP INT LOCK GLASS SLIDER	1.000	PC				
					Code	Description	Qty	UOM																	
					VI1998A0	ZINC PLATED SCREW 5X30 TCB	2.000	PC																	
VM2471A0	BL SP LOWER CLAMP INT LOCK GLASS SLIDER	1.000	PC																						
VM2472A0	BL SP UPPER CLAMP INT LOCK GLASS SLIDER	1.000	PC																						
VM2503A	SLIDE TO FIX INTERNAL NON REMOV GLASS SP		KVM2503A	BL SP INT FIXED GLASS LOCK 2 PCS KIT	<table border="1"> <thead> <tr> <th>Code</th> <th>Description</th> <th>Qty</th> <th>UOM</th> </tr> </thead> <tbody> <tr> <td>VM2503A0</td> <td>SLIDE TO FIX INTERNAL NON REMOV GLASS SP</td> <td>2.000</td> <td>PC</td> </tr> </tbody> </table>	Code	Description	Qty	UOM	VM2503A0	SLIDE TO FIX INTERNAL NON REMOV GLASS SP	2.000	PC												
					Code	Description	Qty	UOM																	
VM2503A0	SLIDE TO FIX INTERNAL NON REMOV GLASS SP	2.000	PC																						
VM2464A	SHOP.PRO LEFT UPPER CAP DROP DOWN DOOR		KVM2464A	BL SP LEFT UPPER DROPDOWN DOOR CAP KIT	<table border="1"> <thead> <tr> <th>Code</th> <th>Description</th> <th>Qty</th> <th>UOM</th> </tr> </thead> <tbody> <tr> <td>VM2464A0</td> <td>SHOP.PRO LEFT UPPER CAP DROP DOWN DOOR</td> <td>1.000</td> <td>PC</td> </tr> </tbody> </table>	Code	Description	Qty	UOM	VM2464A0	SHOP.PRO LEFT UPPER CAP DROP DOWN DOOR	1.000	PC												
					Code	Description	Qty	UOM																	
VM2464A0	SHOP.PRO LEFT UPPER CAP DROP DOWN DOOR	1.000	PC																						



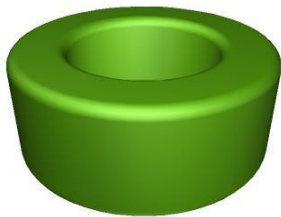

COMPONENT			SPARE PART																		
Code	Description	Image	Code	Description	Kit components																
VM2472A	BL SP UPPER CLAMP INT LOCK GLASS SLIDER		KVM2471A	BL SP INTERNAL GLASS LOCK HOLDER KIT	<table border="1"> <thead> <tr> <th>Code</th> <th>Description</th> <th>Qty</th> <th>UOM</th> </tr> </thead> <tbody> <tr> <td>V11998A0</td> <td>ZINC PLATED SCREW 5X30 TCB</td> <td>2.000</td> <td>PC</td> </tr> <tr> <td>VM2471A0</td> <td>BL SP LOWER CLAMP INT LOCK GLASS SLIDER</td> <td>1.000</td> <td>PC</td> </tr> <tr> <td>VM2472A0</td> <td>BL SP UPPER CLAMP INT LOCK GLASS SLIDER</td> <td>1.000</td> <td>PC</td> </tr> </tbody> </table>	Code	Description	Qty	UOM	V11998A0	ZINC PLATED SCREW 5X30 TCB	2.000	PC	VM2471A0	BL SP LOWER CLAMP INT LOCK GLASS SLIDER	1.000	PC	VM2472A0	BL SP UPPER CLAMP INT LOCK GLASS SLIDER	1.000	PC
Code	Description	Qty	UOM																		
V11998A0	ZINC PLATED SCREW 5X30 TCB	2.000	PC																		
VM2471A0	BL SP LOWER CLAMP INT LOCK GLASS SLIDER	1.000	PC																		
VM2472A0	BL SP UPPER CLAMP INT LOCK GLASS SLIDER	1.000	PC																		
VM2503A	SLIDE TO FIX INTERNAL NON REMOV GLASS SP		KVM2503A	BL SP INT FIXED GLASS LOCK 2 PCS KIT	<table border="1"> <thead> <tr> <th>Code</th> <th>Description</th> <th>Qty</th> <th>UOM</th> </tr> </thead> <tbody> <tr> <td>VM2503A0</td> <td>SLIDE TO FIX INTERNAL NON REMOV GLASS SP</td> <td>2.000</td> <td>PC</td> </tr> </tbody> </table>	Code	Description	Qty	UOM	VM2503A0	SLIDE TO FIX INTERNAL NON REMOV GLASS SP	2.000	PC								
Code	Description	Qty	UOM																		
VM2503A0	SLIDE TO FIX INTERNAL NON REMOV GLASS SP	2.000	PC																		
VM2463A	SHOP.PRO RIGHT UPPER CAP DROP DOWN DOOR		KVM2463A	BL SP RIGHT UPPER DROPDOWN DOOR CAP KIT	<table border="1"> <thead> <tr> <th>Code</th> <th>Description</th> <th>Qty</th> <th>UOM</th> </tr> </thead> <tbody> <tr> <td>VM2463A0</td> <td>SHOP.PRO RIGHT UPPER CAP DROP DOWN DOOR</td> <td>1.000</td> <td>PC</td> </tr> </tbody> </table>	Code	Description	Qty	UOM	VM2463A0	SHOP.PRO RIGHT UPPER CAP DROP DOWN DOOR	1.000	PC								
Code	Description	Qty	UOM																		
VM2463A0	SHOP.PRO RIGHT UPPER CAP DROP DOWN DOOR	1.000	PC																		
TB1562A	DOOR LATERAL BEAM SP600		TB1562A0	DOOR LATERAL BEAM SP600																	
VI1174A	VI1174A0		VI1174A0	VI1174A0																	



COMPONENT			SPARE PART														
Code	Description	Image	Code	Description	Kit components												
VM2461A	BL SP RIGHT LOWER DROPDOWN DOOR CAP KIT		KVM2461A	BL SP RIGHT LOWER DROPDOWN DOOR CAP KIT	<table border="1"> <thead> <tr> <th>Code</th> <th>Description</th> <th>Qty</th> <th>UOM</th> </tr> </thead> <tbody> <tr> <td>VM2461A0</td> <td>BL SP RIGHT LOWER DROPDOWN DOOR CAP KIT</td> <td>1.000</td> <td>PC</td> </tr> </tbody> </table>	Code	Description	Qty	UOM	VM2461A0	BL SP RIGHT LOWER DROPDOWN DOOR CAP KIT	1.000	PC				
Code	Description	Qty	UOM														
VM2461A0	BL SP RIGHT LOWER DROPDOWN DOOR CAP KIT	1.000	PC														
VM2462A	BL SP LEFT LOWER DROPDOWN DOOR CAP		KVM2462A	BL SP LEFT LOWER DROPDOWN DOOR CAP KIT	<table border="1"> <thead> <tr> <th>Code</th> <th>Description</th> <th>Qty</th> <th>UOM</th> </tr> </thead> <tbody> <tr> <td>VM2462A0</td> <td>BL SP LEFT LOWER DROPDOWN DOOR CAP</td> <td>1.000</td> <td>PC</td> </tr> </tbody> </table>	Code	Description	Qty	UOM	VM2462A0	BL SP LEFT LOWER DROPDOWN DOOR CAP	1.000	PC				
Code	Description	Qty	UOM														
VM2462A0	BL SP LEFT LOWER DROPDOWN DOOR CAP	1.000	PC														
VM1630A	INTERNAL GLASS PUSHING CAP		KVM1630A	CAP FOR INTERNAL GLASS 10 PCS KIT	<table border="1"> <thead> <tr> <th>Code</th> <th>Description</th> <th>Qty</th> <th>UOM</th> </tr> </thead> <tbody> <tr> <td>VM1630A1</td> <td>INTERNAL GLASS PUSHING CAP</td> <td>10.000</td> <td>PC</td> </tr> </tbody> </table>	Code	Description	Qty	UOM	VM1630A1	INTERNAL GLASS PUSHING CAP	10.000	PC				
Code	Description	Qty	UOM														
VM1630A1	INTERNAL GLASS PUSHING CAP	10.000	PC														
VM2478A	BL SP GLASS H4 PUSHING BRACKET		KVM2478A	BL SHOP.PRO H4 GLASS SUPPORT 4 PCS KIT	<table border="1"> <thead> <tr> <th>Code</th> <th>Description</th> <th>Qty</th> <th>UOM</th> </tr> </thead> <tbody> <tr> <td>VM1630A1</td> <td>INTERNAL GLASS PUSHING CAP</td> <td>4.000</td> <td>PC</td> </tr> <tr> <td>VM2478A0</td> <td>BL SP GLASS H4 PUSHING BRACKET</td> <td>4.000</td> <td>PC</td> </tr> </tbody> </table>	Code	Description	Qty	UOM	VM1630A1	INTERNAL GLASS PUSHING CAP	4.000	PC	VM2478A0	BL SP GLASS H4 PUSHING BRACKET	4.000	PC
Code	Description	Qty	UOM														
VM1630A1	INTERNAL GLASS PUSHING CAP	4.000	PC														
VM2478A0	BL SP GLASS H4 PUSHING BRACKET	4.000	PC														
CE1095A	4 POLES MICROFIT 2 M BUS CABLE		KCE1095A	4POLES 2M BUS CABLE KIT POWER-CONTROL	<table border="1"> <thead> <tr> <th>Code</th> <th>Description</th> <th>Qty</th> <th>UOM</th> </tr> </thead> <tbody> <tr> <td>CE1095A0</td> <td>4 POLES MICROFIT 2 M BUS CABLE</td> <td>1.000</td> <td>PC</td> </tr> </tbody> </table>	Code	Description	Qty	UOM	CE1095A0	4 POLES MICROFIT 2 M BUS CABLE	1.000	PC				
Code	Description	Qty	UOM														
CE1095A0	4 POLES MICROFIT 2 M BUS CABLE	1.000	PC														

COMPONENT			SPARE PART																		
Code	Description	Image	Code	Description	Kit components																
CE1285A	EMI ROUND FERRITE MOD.2643801502		KCE1285A	ROUND FERRITE ELECTROMAGN PROT. 2PCS KIT	<table border="1"> <thead> <tr> <th>Code</th> <th>Description</th> <th>Qty</th> <th>UOM</th> </tr> </thead> <tbody> <tr> <td>CE1285A0</td> <td>EMI ROUND FERRITE MOD.2643801502</td> <td>2.000</td> <td>PC</td> </tr> </tbody> </table>	Code	Description	Qty	UOM	CE1285A0	EMI ROUND FERRITE MOD.2643801502	2.000	PC								
Code	Description	Qty	UOM																		
CE1285A0	EMI ROUND FERRITE MOD.2643801502	2.000	PC																		
CR1112A	CR1112A1		KCR1112A	BAKERLUX SP ARIANNA-ELENA HINGE KIT	<table border="1"> <thead> <tr> <th>Code</th> <th>Description</th> <th>Qty</th> <th>UOM</th> </tr> </thead> <tbody> <tr> <td>CR1112A1</td> <td>CR1112A1</td> <td>1.000</td> <td>PC</td> </tr> <tr> <td>VI1280A3</td> <td>M5x10 TC1/2T SCREW</td> <td>3.000</td> <td>PC</td> </tr> </tbody> </table>	Code	Description	Qty	UOM	CR1112A1	CR1112A1	1.000	PC	VI1280A3	M5x10 TC1/2T SCREW	3.000	PC				
Code	Description	Qty	UOM																		
CR1112A1	CR1112A1	1.000	PC																		
VI1280A3	M5x10 TC1/2T SCREW	3.000	PC																		
PE2107A	BAKERLUX SHOP.PRO LED COMPLETE CONTROL		KPE2107A	BAKERLUX SP LED CONTROL BOARD KIT	<table border="1"> <thead> <tr> <th>Code</th> <th>Description</th> <th>Qty</th> <th>UOM</th> </tr> </thead> <tbody> <tr> <td>PE2107A2</td> <td>BAKERLUX SHOP.PRO LED COMPLETE CONTROL</td> <td>1.000</td> <td>PC</td> </tr> <tr> <td>VI1147A0</td> <td>5X25 STAINLESS STEEL SCREW</td> <td>2.000</td> <td>PC</td> </tr> <tr> <td>VM1447A0</td> <td></td> <td>1.000</td> <td>PC</td> </tr> </tbody> </table>	Code	Description	Qty	UOM	PE2107A2	BAKERLUX SHOP.PRO LED COMPLETE CONTROL	1.000	PC	VI1147A0	5X25 STAINLESS STEEL SCREW	2.000	PC	VM1447A0		1.000	PC
Code	Description	Qty	UOM																		
PE2107A2	BAKERLUX SHOP.PRO LED COMPLETE CONTROL	1.000	PC																		
VI1147A0	5X25 STAINLESS STEEL SCREW	2.000	PC																		
VM1447A0		1.000	PC																		
VI1174A	VI1174A0		VI1174A0	VI1174A0																	
VM2512A	BL SP DOOR-MICROSWITC H SOFT CLOSING		KVM2512A	BL SP DOOR-MICROSWITC H SOFT CLOSING KI	<table border="1"> <thead> <tr> <th>Code</th> <th>Description</th> <th>Qty</th> <th>UOM</th> </tr> </thead> <tbody> <tr> <td>VM2512A0</td> <td>BL SP DOOR-MICRO SWITCH SOFT CLOSING</td> <td>1.000</td> <td>PC</td> </tr> </tbody> </table>	Code	Description	Qty	UOM	VM2512A0	BL SP DOOR-MICRO SWITCH SOFT CLOSING	1.000	PC								
Code	Description	Qty	UOM																		
VM2512A0	BL SP DOOR-MICRO SWITCH SOFT CLOSING	1.000	PC																		





COMPONENT			SPARE PART																						
Code	Description	Image	Code	Description	Kit components																				
VT1218A	SP ARIANNA 357x439x4 EXT BLACK GLASS		KVT1218A	BL S.Pro ARIANNA EXT BLACK GLASS KIT	<table border="1"> <thead> <tr> <th>Code</th> <th>Description</th> <th>Qty</th> <th>UOM</th> </tr> </thead> <tbody> <tr> <td>0B0387A0</td> <td>SP ARI-ROS EXT GLASS SUPPORT PROFILE</td> <td>2.000</td> <td>PC</td> </tr> <tr> <td>SL1186A1</td> <td></td> <td>2.000</td> <td>PC</td> </tr> <tr> <td>VI1220A1</td> <td>4,2x12 TCB SELF-TAPPIN G SCREW</td> <td>6.000</td> <td>PC</td> </tr> <tr> <td>VT1218A0</td> <td>SP ARIANNA 357x439x4 EXT BLACK GLASS</td> <td>1.000</td> <td>PC</td> </tr> </tbody> </table>	Code	Description	Qty	UOM	0B0387A0	SP ARI-ROS EXT GLASS SUPPORT PROFILE	2.000	PC	SL1186A1		2.000	PC	VI1220A1	4,2x12 TCB SELF-TAPPIN G SCREW	6.000	PC	VT1218A0	SP ARIANNA 357x439x4 EXT BLACK GLASS	1.000	PC
					Code	Description	Qty	UOM																	
					0B0387A0	SP ARI-ROS EXT GLASS SUPPORT PROFILE	2.000	PC																	
					SL1186A1		2.000	PC																	
VI1220A1	4,2x12 TCB SELF-TAPPIN G SCREW	6.000	PC																						
VT1218A0	SP ARIANNA 357x439x4 EXT BLACK GLASS	1.000	PC																						
VT1330A	SP ARIANNA 515x393.5x4 INNER GLASS		KVT1330A	BL SP ARIANNA INTERNAL DOOR GLASS KIT	<table border="1"> <thead> <tr> <th>Code</th> <th>Description</th> <th>Qty</th> <th>UOM</th> </tr> </thead> <tbody> <tr> <td>VT1330A0</td> <td>SP ARIANNA 515x393.5x4 INNER GLASS</td> <td>1.000</td> <td>PC</td> </tr> </tbody> </table>	Code	Description	Qty	UOM	VT1330A0	SP ARIANNA 515x393.5x4 INNER GLASS	1.000	PC												
					Code	Description	Qty	UOM																	
VT1330A0	SP ARIANNA 515x393.5x4 INNER GLASS	1.000	PC																						

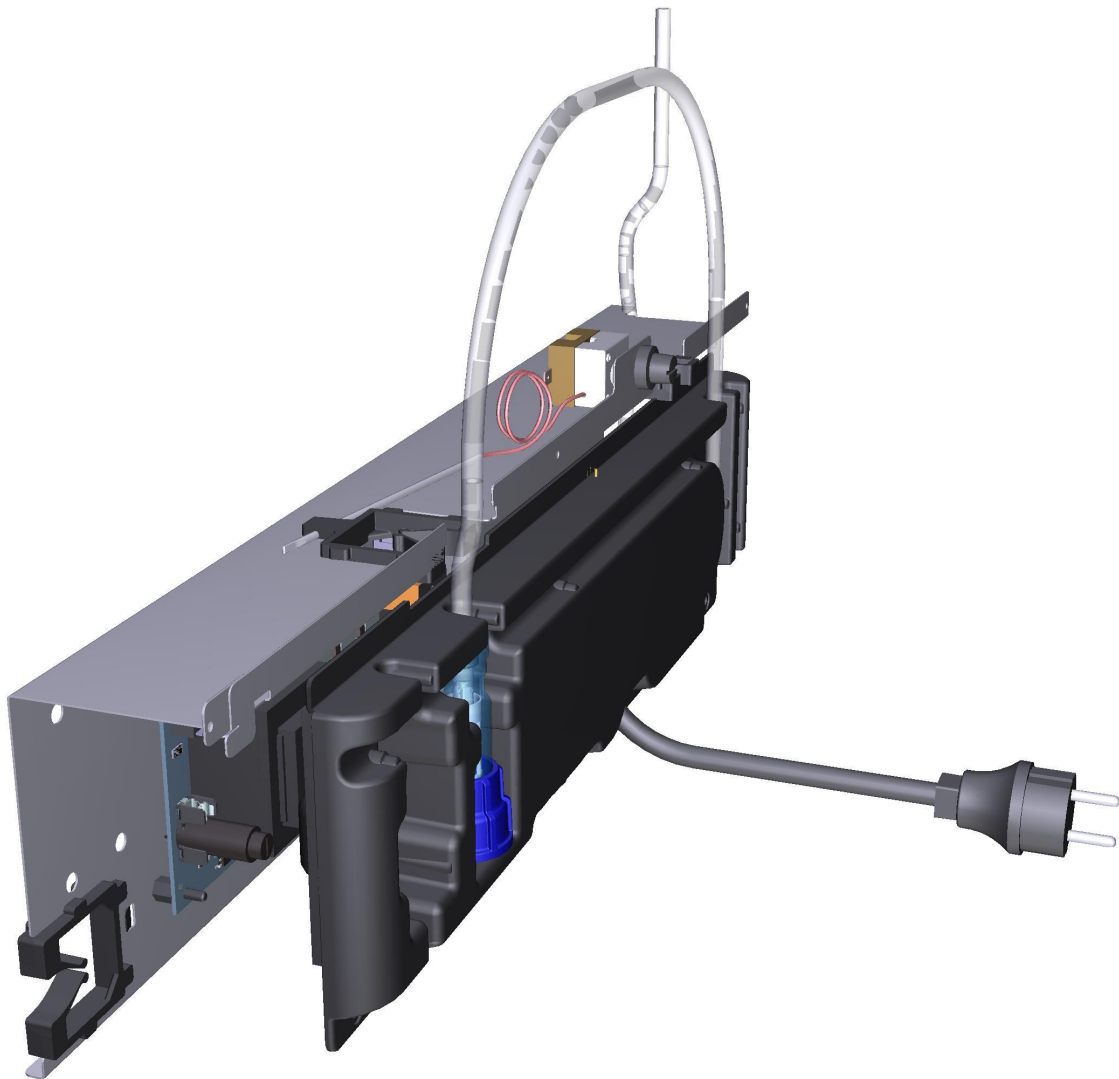

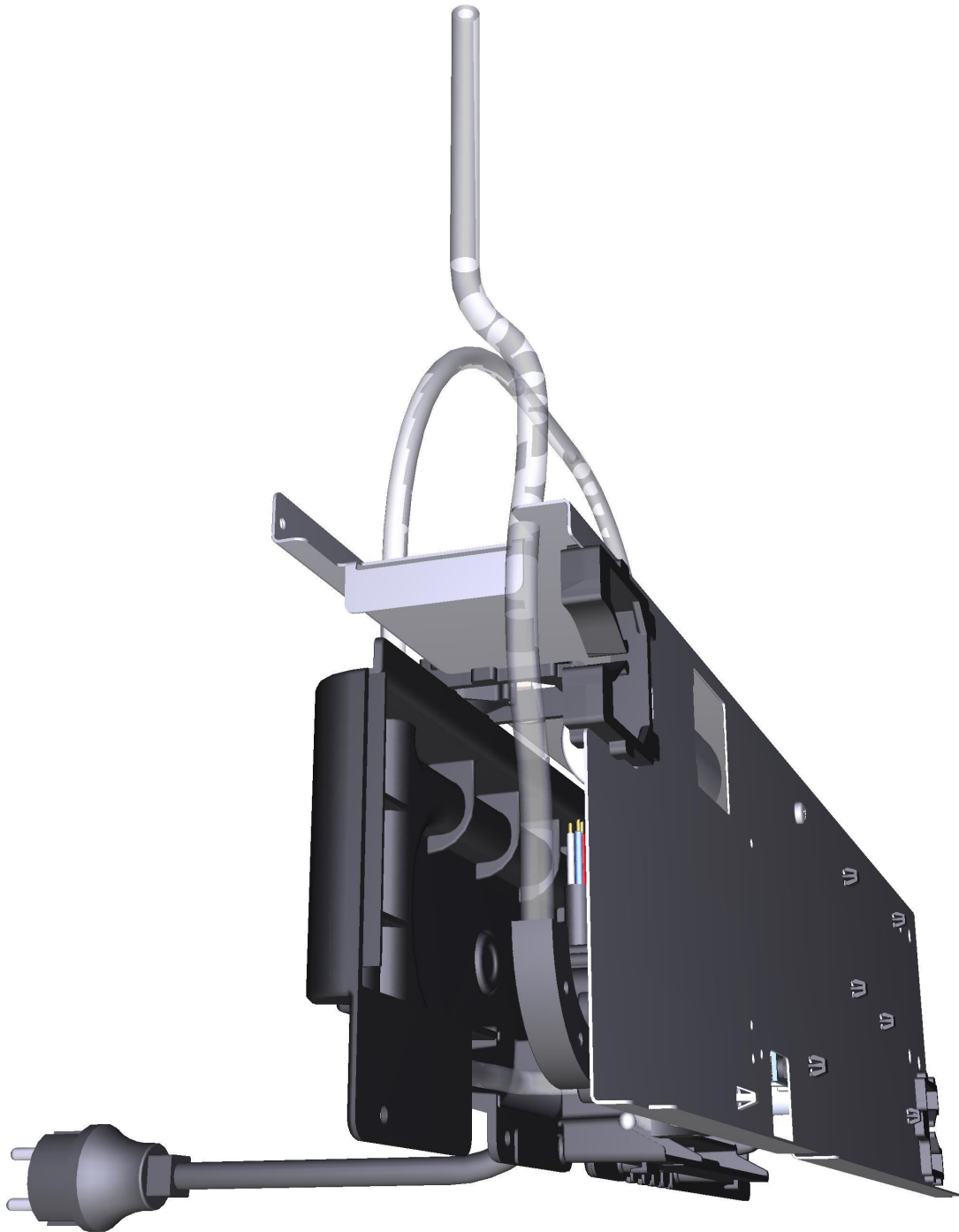

ASM8225A/0.D00 - Electrical system - FRONT



ASM8225A/0.D00 - Electrical system - REAR



COMPONENT			SPARE PART																										
Code	Description	Image	Code	Description	Kit components																								
0P1052A	SP600 SINGLE MOTOR BOARD WIRING HOLDER		0P1052A0	SP600 SINGLE MOTOR BOARD WIRING HOLDER																									
VL1145A	VL1145A1		KVL1145A	3/4-JG8 FITTING WITH FILTER AND NRV KIT	<table border="1"> <thead> <tr> <th>Code</th> <th>Description</th> <th>Qty</th> <th>UOM</th> </tr> </thead> <tbody> <tr> <td>VL1145A1</td> <td>VL1145A1</td> <td>1.000</td> <td>PC</td> </tr> </tbody> </table>	Code	Description	Qty	UOM	VL1145A1	VL1145A1	1.000	PC																
Code	Description	Qty	UOM																										
VL1145A1	VL1145A1	1.000	PC																										
PE1463A	SHOP.Pro 230V 03HS-04HS POWER CARD		KPE1463A	SHOP.Pro 230V 03HS-04HS POWER CARD KIT	<table border="1"> <thead> <tr> <th>Code</th> <th>Description</th> <th>Qty</th> <th>UOM</th> </tr> </thead> <tbody> <tr> <td>PE1463A0</td> <td>SHOP.Pro 230V 03HS-04HS POWER CARD</td> <td>1.000</td> <td>PC</td> </tr> <tr> <td>VI1988A0</td> <td>AUTOTHREAD ING SCREW 4,2x19 TCB+ INOX</td> <td>3.000</td> <td>PC</td> </tr> <tr> <td>VM1187A0</td> <td>POWER BOARD FRAME SHOP.PRO</td> <td>1.000</td> <td>PC</td> </tr> <tr> <td>VM1447A0</td> <td></td> <td>1.000</td> <td>PC</td> </tr> <tr> <td>VM1748A0</td> <td>JOINT-JOINT H10 BOARD FIXING CLIP</td> <td>6.000</td> <td>PC</td> </tr> </tbody> </table>	Code	Description	Qty	UOM	PE1463A0	SHOP.Pro 230V 03HS-04HS POWER CARD	1.000	PC	VI1988A0	AUTOTHREAD ING SCREW 4,2x19 TCB+ INOX	3.000	PC	VM1187A0	POWER BOARD FRAME SHOP.PRO	1.000	PC	VM1447A0		1.000	PC	VM1748A0	JOINT-JOINT H10 BOARD FIXING CLIP	6.000	PC
Code	Description	Qty	UOM																										
PE1463A0	SHOP.Pro 230V 03HS-04HS POWER CARD	1.000	PC																										
VI1988A0	AUTOTHREAD ING SCREW 4,2x19 TCB+ INOX	3.000	PC																										
VM1187A0	POWER BOARD FRAME SHOP.PRO	1.000	PC																										
VM1447A0		1.000	PC																										
VM1748A0	JOINT-JOINT H10 BOARD FIXING CLIP	6.000	PC																										
VM1748A	JOINT-JOINT H10 BOARD FIXING CLIP		VM1748A0	JOINT-JOINT H10 BOARD FIXING CLIP																									

COMPONENT			SPARE PART																		
Code	Description	Image	Code	Description	Kit components																
CE1581A	CABLE H07RNF 3G1.5 L1.5MT+K1/6+SCHU KO		KCE1581A	H07RNF 3G1.5 L1.5 MT + SHUKO PLUG KIT	<table border="1"> <thead> <tr> <th>Code</th> <th>Description</th> <th>Qty</th> <th>UOM</th> </tr> </thead> <tbody> <tr> <td>CE1581A0</td> <td>CABLE H07RNF 3G1.5 L1.5MT+K1/6+ SCHUKO</td> <td>1.000</td> <td>PC</td> </tr> </tbody> </table>	Code	Description	Qty	UOM	CE1581A0	CABLE H07RNF 3G1.5 L1.5MT+K1/6+ SCHUKO	1.000	PC								
Code	Description	Qty	UOM																		
CE1581A0	CABLE H07RNF 3G1.5 L1.5MT+K1/6+ SCHUKO	1.000	PC																		
CN1003A	6,3 Uf MOTOR CAPACITOR		KCN1003A	6,3 uF MOTOR CAPACITOR KIT	<table border="1"> <thead> <tr> <th>Code</th> <th>Description</th> <th>Qty</th> <th>UOM</th> </tr> </thead> <tbody> <tr> <td>CN1003A0</td> <td>6,3 Uf MOTOR CAPACITOR</td> <td>1.000</td> <td>PC</td> </tr> <tr> <td>VI1931A0</td> <td>M8x1.65 H4 CH13 ZINC PLATED NUT</td> <td>1.000</td> <td>PC</td> </tr> <tr> <td>VI1932A0</td> <td>D8 INDENTED ZINC PLATED WASHER</td> <td>1.000</td> <td>PC</td> </tr> </tbody> </table>	Code	Description	Qty	UOM	CN1003A0	6,3 Uf MOTOR CAPACITOR	1.000	PC	VI1931A0	M8x1.65 H4 CH13 ZINC PLATED NUT	1.000	PC	VI1932A0	D8 INDENTED ZINC PLATED WASHER	1.000	PC
Code	Description	Qty	UOM																		
CN1003A0	6,3 Uf MOTOR CAPACITOR	1.000	PC																		
VI1931A0	M8x1.65 H4 CH13 ZINC PLATED NUT	1.000	PC																		
VI1932A0	D8 INDENTED ZINC PLATED WASHER	1.000	PC																		
RC1006A	D8 PET PIPE GUIDE BEND		KRC1006A	20 PCS. Ø8 PET PIPE GUIDE BEND KI	<table border="1"> <thead> <tr> <th>Code</th> <th>Description</th> <th>Qty</th> <th>UOM</th> </tr> </thead> <tbody> <tr> <td>RC1006A0</td> <td>D8 PET PIPE GUIDE BEND</td> <td>20.000</td> <td>PC</td> </tr> </tbody> </table>	Code	Description	Qty	UOM	RC1006A0	D8 PET PIPE GUIDE BEND	20.000	PC								
Code	Description	Qty	UOM																		
RC1006A0	D8 PET PIPE GUIDE BEND	20.000	PC																		
TB3280A	TB3280A0		KTB2529A	Ø8 TRANSPARENT HUMIDITY PIPE 2 M KIT	<table border="1"> <thead> <tr> <th>Code</th> <th>Description</th> <th>Qty</th> <th>UOM</th> </tr> </thead> <tbody> <tr> <td>TB1815A0</td> <td>7,93x4,75 PE TRANSP. PIPE (JG #PE08100N)</td> <td>2.000</td> <td>M</td> </tr> </tbody> </table>	Code	Description	Qty	UOM	TB1815A0	7,93x4,75 PE TRANSP. PIPE (JG #PE08100N)	2.000	M								
Code	Description	Qty	UOM																		
TB1815A0	7,93x4,75 PE TRANSP. PIPE (JG #PE08100N)	2.000	M																		
			KTB1959A	Ø8 TB1815 TRANSPARENT PIPE 5M KIT	<table border="1"> <thead> <tr> <th>Code</th> <th>Description</th> <th>Qty</th> <th>UOM</th> </tr> </thead> <tbody> <tr> <td>TB1815A0</td> <td>7,93x4,75 PE TRANSP. PIPE (JG #PE08100N)</td> <td>5.000</td> <td>M</td> </tr> </tbody> </table>	Code	Description	Qty	UOM	TB1815A0	7,93x4,75 PE TRANSP. PIPE (JG #PE08100N)	5.000	M								
Code	Description	Qty	UOM																		
TB1815A0	7,93x4,75 PE TRANSP. PIPE (JG #PE08100N)	5.000	M																		
TR1136A	318°C -0/+24 1 POLE SAFETY THERMOSTAT		KTR1136A	318°C -0/+24 SAFETY THERMOSTAT KIT	<table border="1"> <thead> <tr> <th>Code</th> <th>Description</th> <th>Qty</th> <th>UOM</th> </tr> </thead> <tbody> <tr> <td>0H8120A0</td> <td>XEVL BULB PASS-THROU GH COVER</td> <td>1.000</td> <td>PC</td> </tr> <tr> <td>GN1531A0</td> <td>THERMOSTAT BULB INLET SEALING</td> <td>1.000</td> <td>PC</td> </tr> <tr> <td>SL1045A0</td> <td>S57 BLACK SILICONE - 80ml CARTRIDGE</td> <td>1.000</td> <td>PC</td> </tr> </tbody> </table>	Code	Description	Qty	UOM	0H8120A0	XEVL BULB PASS-THROU GH COVER	1.000	PC	GN1531A0	THERMOSTAT BULB INLET SEALING	1.000	PC	SL1045A0	S57 BLACK SILICONE - 80ml CARTRIDGE	1.000	PC
Code	Description	Qty	UOM																		
0H8120A0	XEVL BULB PASS-THROU GH COVER	1.000	PC																		
GN1531A0	THERMOSTAT BULB INLET SEALING	1.000	PC																		
SL1045A0	S57 BLACK SILICONE - 80ml CARTRIDGE	1.000	PC																		

COMPONENT			SPARE PART														
Code	Description	Image	Code	Description	Kit components												
TR1136A	318°C -0/+24 1 POLE SAFETY THERMOSTAT		KTR1136A	318°C -0/+24 SAFETY THERMOSTAT KIT	<table border="1"> <thead> <tr> <th>Code</th> <th>Description</th> <th>Qty</th> <th>UOM</th> </tr> </thead> <tbody> <tr> <td>TR1136A0</td> <td>318°C -0/+24 1 POLE SAFETY THERMOSTAT</td> <td>1.000</td> <td>PC</td> </tr> <tr> <td>VI1220A1</td> <td>4,2x12 TCB SELF-TAPPING SCREW</td> <td>3.000</td> <td>PC</td> </tr> </tbody> </table>	Code	Description	Qty	UOM	TR1136A0	318°C -0/+24 1 POLE SAFETY THERMOSTAT	1.000	PC	VI1220A1	4,2x12 TCB SELF-TAPPING SCREW	3.000	PC
Code	Description	Qty	UOM														
TR1136A0	318°C -0/+24 1 POLE SAFETY THERMOSTAT	1.000	PC														
VI1220A1	4,2x12 TCB SELF-TAPPING SCREW	3.000	PC														
VI1328A	VI1328A0		VI1328A0	VI1328A0													
VM1188A	POWER BOARD WIRES PASS-THROUGH		KVM1188A	POWER BOARD WIRES PASS-THROUGH 10PCS KIT	<table border="1"> <thead> <tr> <th>Code</th> <th>Description</th> <th>Qty</th> <th>UOM</th> </tr> </thead> <tbody> <tr> <td>VM1188A0</td> <td>POWER BOARD WIRES PASS-THROUGH</td> <td>10.000</td> <td>PC</td> </tr> </tbody> </table>	Code	Description	Qty	UOM	VM1188A0	POWER BOARD WIRES PASS-THROUGH	10.000	PC				
Code	Description	Qty	UOM														
VM1188A0	POWER BOARD WIRES PASS-THROUGH	10.000	PC														
VM2482A	ELECTR COMPONENTS HOLDER FRAME SHOP.PRO		KVM2482A	BAKERLUX SP ELECTR COMPONENTS HOLDER KIT	<table border="1"> <thead> <tr> <th>Code</th> <th>Description</th> <th>Qty</th> <th>UOM</th> </tr> </thead> <tbody> <tr> <td>VM2482A0</td> <td>ELECTR COMPONENTS HOLDER FRAME SHOP.PRO</td> <td>1.000</td> <td>PC</td> </tr> <tr> <td>VM2484A0</td> <td>ELECTRICAL CONNECTION CABLE CLAMP</td> <td>1.000</td> <td>PC</td> </tr> </tbody> </table>	Code	Description	Qty	UOM	VM2482A0	ELECTR COMPONENTS HOLDER FRAME SHOP.PRO	1.000	PC	VM2484A0	ELECTRICAL CONNECTION CABLE CLAMP	1.000	PC
Code	Description	Qty	UOM														
VM2482A0	ELECTR COMPONENTS HOLDER FRAME SHOP.PRO	1.000	PC														
VM2484A0	ELECTRICAL CONNECTION CABLE CLAMP	1.000	PC														
VM2483A	SHOP PRO COMPONENTS HOLDER COVER		KVM2483A	BL SHOP.PRO COMPONENTS HOLDER COVER KIT	<table border="1"> <thead> <tr> <th>Code</th> <th>Description</th> <th>Qty</th> <th>UOM</th> </tr> </thead> <tbody> <tr> <td>VM2483A1</td> <td>SHOP PRO COMPONENTS HOLDER COVER</td> <td>1.000</td> <td>PC</td> </tr> </tbody> </table>	Code	Description	Qty	UOM	VM2483A1	SHOP PRO COMPONENTS HOLDER COVER	1.000	PC				
Code	Description	Qty	UOM														
VM2483A1	SHOP PRO COMPONENTS HOLDER COVER	1.000	PC														



COMPONENT			SPARE PART											
Code	Description	Image	Code	Description	Kit components									
VM2484A	ELECTRICAL CONNECTION CABLE CLAMP		KVM2484A	CABLE LOCKS ELECTRICAL CONNECTION KIT	<table border="1"> <thead> <tr> <th>Code</th> <th>Description</th> <th>Qty</th> <th>UOM</th> </tr> </thead> <tbody> <tr> <td>VM2484A0</td> <td>ELECTRICAL CONNECTION CABLE CLAMP</td> <td>1.000</td> <td>PC</td> </tr> </tbody> </table>	Code	Description	Qty	UOM	VM2484A0	ELECTRICAL CONNECTION CABLE CLAMP	1.000	PC	
			Code	Description	Qty	UOM								
VM2484A0	ELECTRICAL CONNECTION CABLE CLAMP	1.000	PC											
KVM2482A	BAKERLUX SP ELECTR COMPONENTS HOLDER KIT	<table border="1"> <thead> <tr> <th>Code</th> <th>Description</th> <th>Qty</th> <th>UOM</th> </tr> </thead> <tbody> <tr> <td>VM2482A0</td> <td>ELECTR COMPONENT S HOLDER FRAME SHOP.PRO</td> <td>1.000</td> <td>PC</td> </tr> <tr> <td>VM2484A0</td> <td>ELECTRICAL CONNECTION CABLE CLAMP</td> <td>1.000</td> <td>PC</td> </tr> </tbody> </table>	Code	Description	Qty	UOM	VM2482A0	ELECTR COMPONENT S HOLDER FRAME SHOP.PRO	1.000	PC	VM2484A0	ELECTRICAL CONNECTION CABLE CLAMP	1.000	PC
Code	Description	Qty	UOM											
VM2482A0	ELECTR COMPONENT S HOLDER FRAME SHOP.PRO	1.000	PC											
VM2484A0	ELECTRICAL CONNECTION CABLE CLAMP	1.000	PC											